

Varenummer: 2031100M16125C3U

Beskrivelse: E+G Justerfod  
GN 31-100-M16-125-C3-U

Note: U Uden møtrik, sekskant i toppen, spændeflade i bunden

## Mål

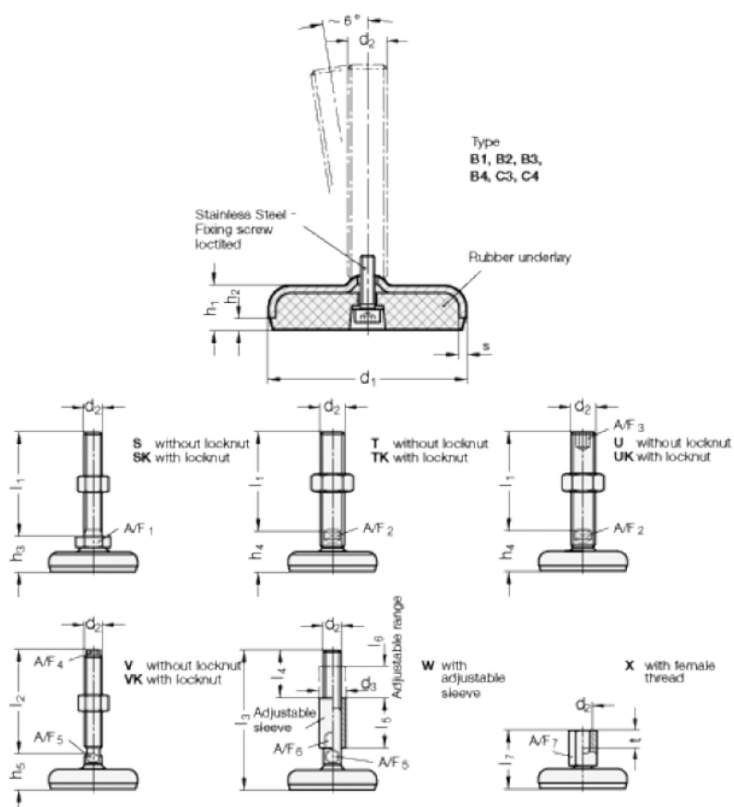

A/F2	= 12	s = 3
A/F3	= 8	
d1	= 100	
d2	= 16	
h1	= 20	
h4 +4.0/0	= 34	
l1	= 125	